

i-PIX

User Manual

SATELLITE

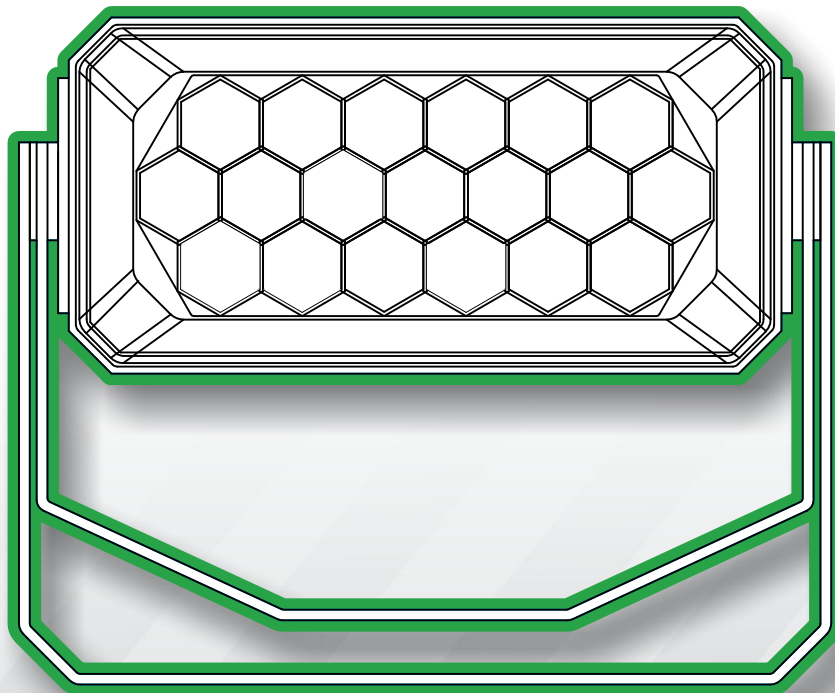

contents

INTRO, RIGGING, SET UP & MODES

SAFETY FIRST	page 3
THE SATELLITE	page 5
RIGGING	page 6
SET UP	page 7
MODES	page 8

OPERATING INSTRUCTIONS

STAND ALONE FUNCTIONS	page 9
STORING A DMX INPUT AS A MEMORY	page 9
CREATING A MEMORY	page 10
RECALLING A MEMORY	page 13
CREATING A CHASE	page 14
SATELLITE AS A DMX OUTPUT	page 16

THE TECHNICAL STUFF

TECHNICAL SPECIFICATIONS	page 16
UNIT DIMENSIONS DRAWINGS	page 17
TROUBLE SHOOTING	page 18

APPENDICES

APPENDIX 1	ROHS COMPLIANCE AND WEEE DIRECTIVE INSTRUCTIONS	page 20
APPENDIX 2	SERVICE CONTACT DETAILS	page 21

SAFETY FIRST



WARNING!
Read the safety precautions in this section before installing, powering, operating or servicing the SATELLITE

The following symbols are used to identify important safety information in this manual:



Warning!
Safety hazard. Risk of severe injury or death

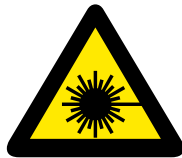

Warning!
LED light emission. Risk of eye injury

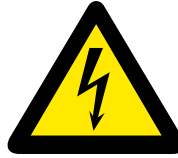

Warning!
Hazardous voltage. Risk of lethal or severe electric shock



Warning!
Fire hazard

! Read this manual before installing, powering or servicing the fixture, follow the safety precautions listed below and observe all warnings in this manual. If you have questions about how to operate the fixture safely, please contact I-Pix.



Warning! Class 2M LED product. Do not look into the beam from a distance of less than 40 cm (16 inches). Do not stare into the beam for extended periods at a short distance. Do not view the beam directly with optical instruments.



This product is for professional use only. It is not for household use. This product presents risks of severe injury or death due to fire hazards, electric shock and falls.



PROTECTION FROM ELECTRIC SHOCK

Shut down power to the entire installation at the building's main power distribution board and lock out power (by removing the fuse for example) before carrying out any installation or maintenance work.

Disconnect the fixture from AC power before removing or installing any cover or part and when not in use.

Always ground (earth) the fixture electrically.

Use only a source of AC power that complies with local building and electrical codes and has both overload and ground-fault (earth-fault) protection.

Connect this fixture to AC power either using the supplied power cable or via 3- conductor cable that is rated minimum 20 amp, hard usage. Suitable cable types include ST, SJT, STW, SEO, SEOW and STO.

The voltage and frequency at the power outlet are the same as the voltage and frequency applied to the power inlet. Only connect devices to the power outlet that accept this voltage and frequency.

Before using the fixture, check that all power distribution equipment and cables are in perfect condition and rated for the current requirements of all connected devices.

Do not use the fixture if the power cable or power plug are in any way damaged, defective or wet, or if they show signs of overheating.



PROTECTION FROM FIRE

Do not attempt to bypass thermostatic switches or fuses. Replace defective fuses with ones of the specified type and rating only.

Provide a minimum clearance of 0.1 m (4 in.) around fans and air vents.

Do not modify the fixture

Apart from I-PIX accessories do not stick filters, masks or other materials directly onto the light.



PROTECTION FROM INJURY

When suspending the fixture, ensure that the structure and all hardware used can hold at least 10 times the weight of all devices suspended from them.

Use two secondary attachments (such as a safety cable) to secure each fixture. Secondary attachments must be able to hold at least 10 times the weight of all devices suspended from them and must be installed as described in this manual.

Check that all external covers and rigging hardware are securely fastened.

Block access below the work area and work from a stable platform whenever installing, servicing or moving the fixture.



The LED emission presents a hazard to eyesight at a distance of 4 - 40 cm (1.6 -16 inches) when the eye is exposed to the beam for longer than 0.25 seconds.

Do not look at LEDs from a distance of less than 40 cm (1ft. 4in.) without suitable protective eye wear.

Do not look at LEDs with magnifiers or similar optical instruments that may concentrate the light output.

i-PIX

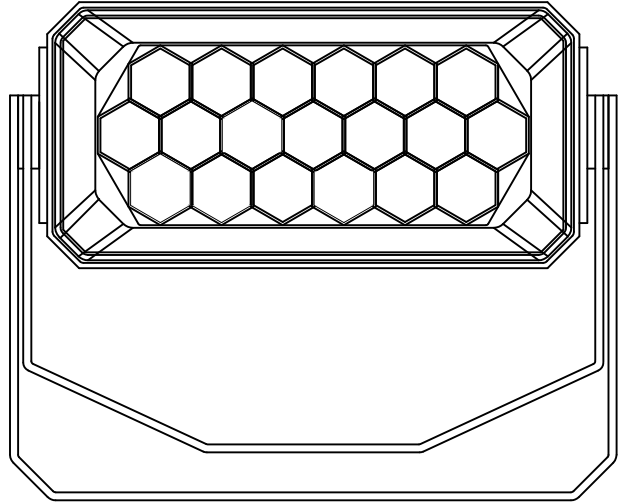

Satellite

The i-pix Satellite unit is based on proven LED lighting techniques, but it incorporates substantial improvements due to the use of modern digital technology involving microprocessor base controls and PWM (pulse width modulation) switching. This gives the unit ultra smooth dimmer response, an easy-to-read LCD user interface, easy address and set up functionality, plus the added benefit that users can utilise the onboard software to create their own internal chase sequences when used in stand alone mode.

Good functional design ensures that the Satellite is a very competitive and versatile unit with features that make it easy to use and set-up. For ease of operation, compatibility and versatility the Satellite can be set into either 3 or 5 channel modes when it is to be controlled by an external DMX source, depending on the complexity, functionality and circumstances of the particular lighting situation, making the unit the ideal choice for most general wash lighting applications.

* Even though the Satellite is extremely easy to set-up and use, as a product it is aimed at lighting professional. Thus for the purposes of this manual it is assumed that users have a basic understanding of lighting technologies like DMX etc.

RIGGING

The Satellite is a very simple light to rig all that is necessary is to bolt your clamp of choice to the yoke obviously selecting one that is well capable of taking the weight of the light and then using at least one safety bond attached to one of the 2 safety points shown here as A and B in fig 1.

fig 1

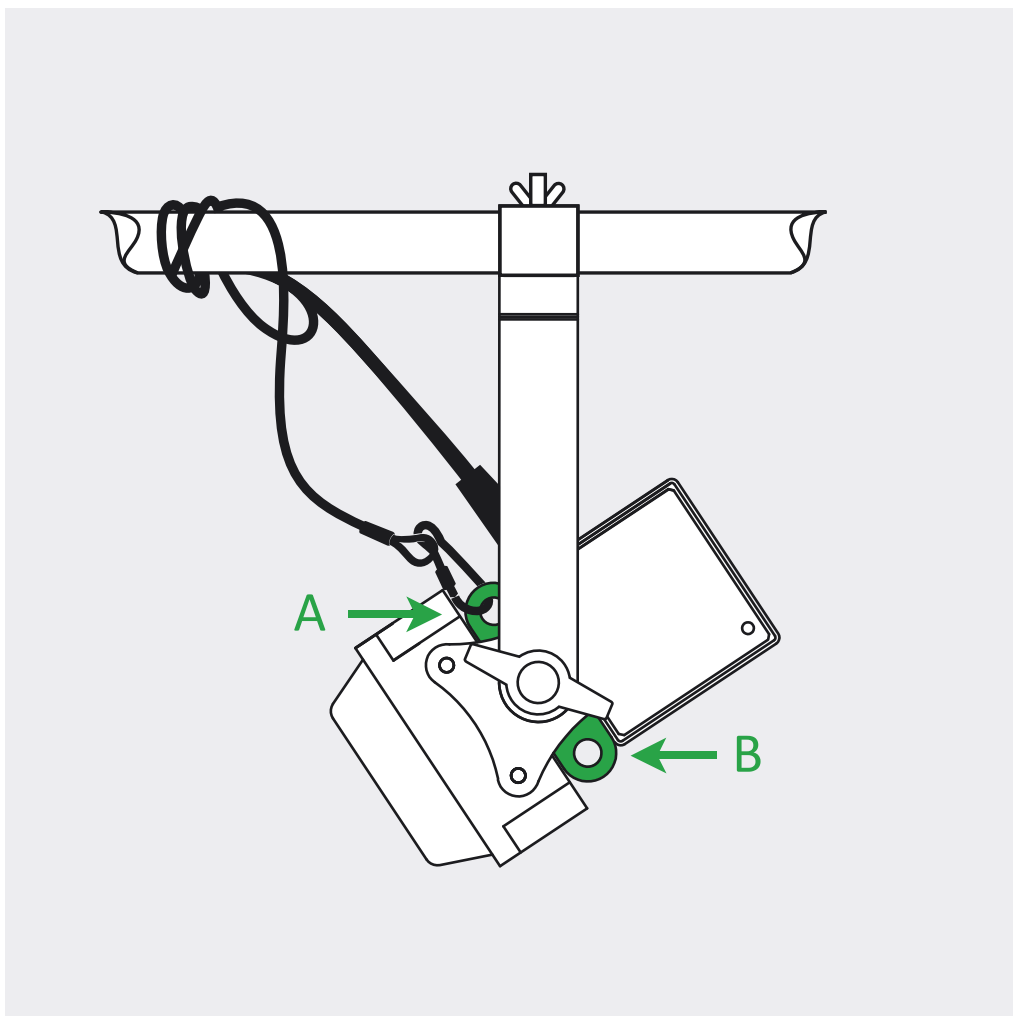

SET UP

1 select appropriate dimmer curve

The Satellite offers a choice of two dimmer curves.

- 1 LINEAR - the output increases directly with dmx input.
- 2 ENHANCED - the first 10% of the output is controlled over the first 50% of the DMX input.

First press the button above the MENU legend.



Then select the appropriate dimmer curve.

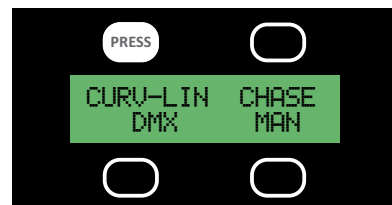

2 Select appropriate mode

The Satellite offers a choice of two operating modes. Both of which are described in detail below.

To select a mode
Keep the button below the MODE legend depressed and go through the modes.



3 Select appropriate address

First press the button above the ADDR legend.



Then change the address using the 100s,10s & 1s buttons.

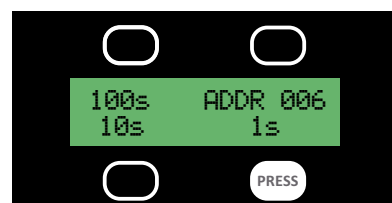

THE OPERATING MODES

The Satellite has 2 different operating modes, to suit different uses, programming styles and dmx configurations.

MODE 1 - 3 channels 8 bit

The most simple, ideal for fast programming, limited dmx linespace or as a node on a media server.

ch1 - red
ch2 - green
ch3 - blue

MODE 3 - 5 channels 8 bit

Ideal for fast programming, limited dmx line space with overall dimming and strobe control.

ch1 - master intensity
ch2 - strobe
ch3 - red
ch4 - green
ch5 - blue

Stand alone functions

The Satellite is able to run in a stand alone mode without any need of data from a lighting desk. The light is capable of outputting up to 20 programmable memories and 1 chase that steps through these memories.

“The Satellite must be in 5 CHANNEL MODE for the stand alone functions to work.”

Storing a DMX Input as a Memory

However if you have access to a lighting desk a quick and easy way to create multiple or complex memories is to give the light the desired colour information using a lighting desk or similar DMX generating device and use the STORE function.

1 Connect the light to the desk in the usual way making sure the address is correct and the Satellite is in 5 CHANNEL MODE.

2 Create the desired colour on the lighting desk.

3 Press the button underneath the STORE legend once.



4 You should then assign this memory a number using the UP, DOWN button.



5 When you are happy this memory has been numbered correctly press the STORE button wait 3 seconds and the display will return to the main menu.



Creating a memory

1 Press the button above the MENU legend once.



2 Press the button underneath the MAN (manual) legend once.



3 Press the button underneath the PROG MEM (program memory) legend once.

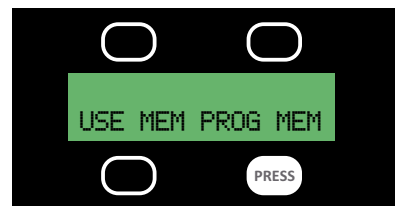

You are now presented with the first variable of your memory which is the Master Intensity (MINT). The default value for the MINT is 100% - intensity full.

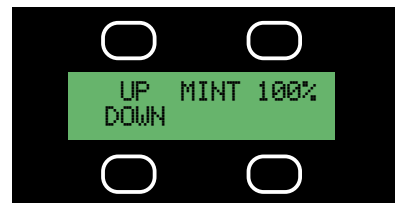

If you wish to alter this value use the buttons above and below the UP & DOWN legends until you have the desired % value.



4 When happy with the MINT value press the button above MINT once.



Next you are presented with STRB (strobe) the second variable of your memory which has a default value of 0% - no strobe.



In the same way if you wish to alter this value use the UP & DOWN buttons to give you the desired % value.

5 When happy with the STRB value press the button above STRB once.

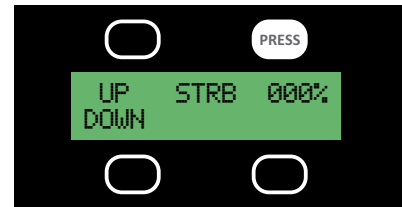

Now you are presented with the first colour RED (default 0%).

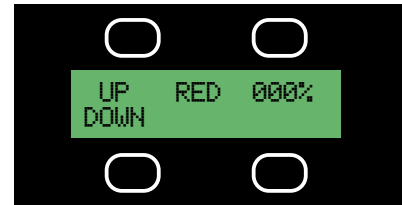

In the same way if you wish to alter this value use the UP, DOWN buttons to give you the desired %. If you require 100% press the DOWN button.

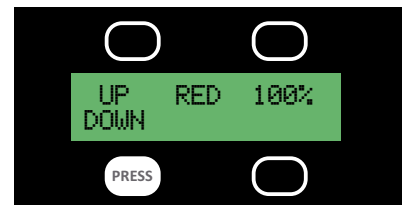

6 When happy with the RED value press the button above RED once.

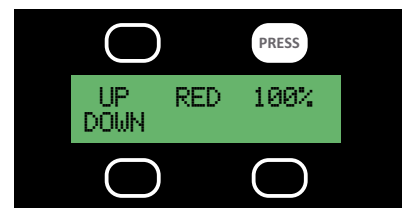

Next you are presented with the second colour GREEN (default 0%)

In the same way if you wish to alter this value use the UP, DOWN buttons to give you the desired %
If you require 100% press the DOWN button.

7 When happy with the GREEN value press the button above GREEN once.



Finally you are presented with the third colour BLUE (default 0%).

In the same way if you wish to alter this value use the UP, DOWN buttons to give you the desired %.
If you require 100% press the DOWN button.

8 When happy with the BLUE value press the button above BLUE once.



Now you are given the opportunity to store your memory. If you are satisfied with all the values you have inputted.



If however you think you may have made a mistake or you have just changed your mind then you can return to the start of the memory by pressing MEM button and repeating the above process.



If you are happy with your memory you should then assign it a number using the UP, DOWN buttons.



9 When happy with your memory number press STORE.



To Recall A Memory

1 Press the button above the MENU legend once then.



2 Press the button underneath the MAN (manual) legend once then.

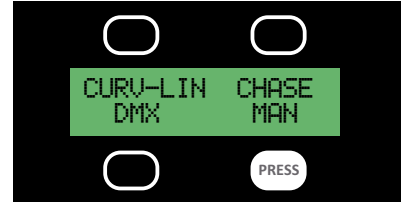

3 Press the button underneath the USE MEM (use memory) legend.

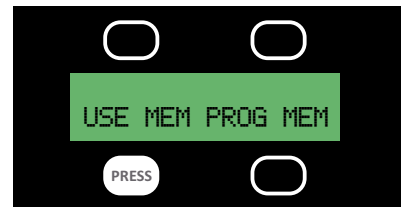

Now you will be offered the first memory MEM 01.
This will come on automatically.



4 To select any other memory simply use the UP, DOWN buttons until you find the memory you want.

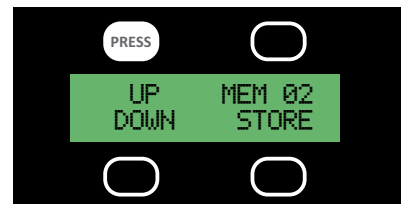

The memories will come on as you select them.

“ IF YOU WISH YOUR MEMORY TO COME ON AS SOON AS YOU GIVE THE LAMP POWER YOU WILL NEED TO PROGRAMME IT AS A TWO STEP CHASE WITH BOTH MEMORIES HAVING THE SAME VALUE”

To return to the main menu press the DMX MODE button

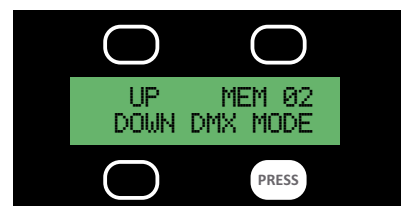

Programming a Chase

1 Ensure you have programmed all the memories that will go to make up the steps of your chase.



2 Press the button underneath the MORE legend once.



3 Press the button above the CHASE legend once.

Now the WAIT TIME will appear this is the first variable of the chase to be set. The WAIT TIME is the time period between cross fades that the colour is held constant for.

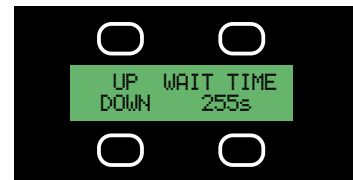

Select the appropriate time (in seconds) using the UP, DOWN buttons.

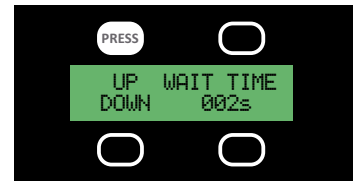

4 When you are happy with the WAIT TIME press the button above WAIT TIME once.

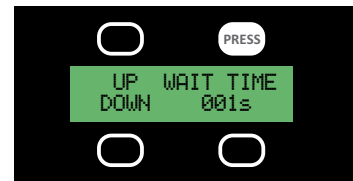

Now the XFADE TIME (cross fade time) will appear this is the second variable of the chase to be set. The XFADE TIME is the length of time the light takes to change from one colour to another.

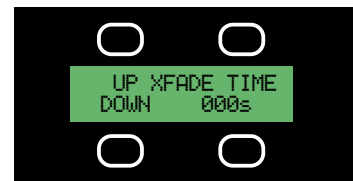

Select the appropriate time (in seconds) using the UP, DOWN buttons.

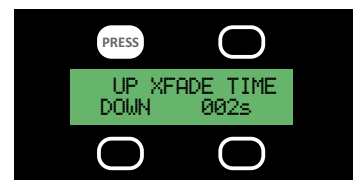

5 Once you are happy with the XFADE TIME press the button above XFADE TIME once.

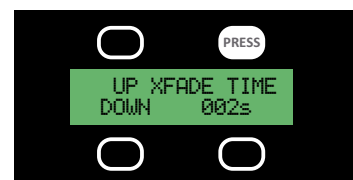

Now CHASE STRT (chase start) will appear along with the option MEM 1. This will be the first step of your chase.

Choose which memory you would like to be the first step of your chase using the UP, DOWN buttons.

6 Once you are happy with the memory that will be your first step press the button above CHASE STRT.



Now CHASE END will appear along with the option MEM 1. This will be the last step of your chase. The chase will run through all the memories numbered between the first and last step.

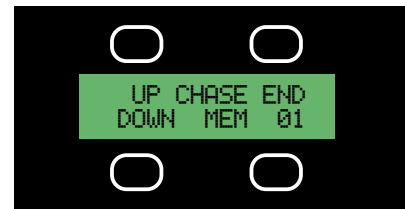

Choose which memory you would like to be the last step of your chase using the UP, DOWN buttons.

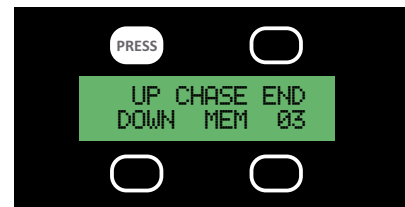

7 Once you are happy with the memory that will be your last step press the button above CHASE END once.

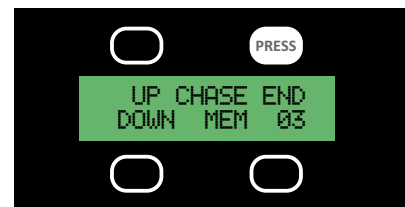

Now you will be offered the option USE CHASE, if you wish to simply press yes.



The interface will now say CHASE RUNNING. When you wish to end or change the chase press MENU.



If you leave a chase running when the light is powered down the chase will resume as soon as the light is powered back up again.

! If the chase does not run try re-recording the first step again

Satellite as a dmx output

The Satellite has the ability output dmx.

Either outputting its internal memory state or a chase.

The outputting Satellite (master) must be in 5 channel mode address 001.

The other units down the dmx stream (slaves) must also be in 5 channel mode address 001.

This would be mode 3 on a BB4 & BB7 which the Satellite is also capable of outputting to.

Satellite tech spec

Input Voltage	90-264 VAC
Input Frequency	47-63 Hz
Input Current constant	0.4 A max at 230 VAC
Inrush Current	40 A max at 230 VAC
Earth Leakage Current	<100 µA at 115 VAC <200 µA at 230 VAC
Input Protection	1A anti sure fuse, 5x20mm
Mains input socket	Neutrik NAC3MPA chassis socket type A
Mains output socket	Neutrik NAC3MPB chassis socket type B
DMX input socket	Neutrik NC5MDL1 XLR 5 pole chassis socket
DMX output socket	Neutrik NC5FDL1 XLR 5 pole chassis socket
Mains in/out sockets current	16 A max at 240 VAC
Light Output beam angle	six degrees in a circular dispersion
DMX data specification	DMX 512
Red LED's	6 x Philips LUXEON® I Emitters
Blue LED's	6 x Philips LUXEON® III Emitters
Green LED's	6 x Philips LUXEON® III Emitters
Unit ingress rating	IP20
Operating Temperature	0 °C to 50 °C
Storage Temperature	-20 °C to 60 °C
Weight	3.23Kg (7.12lbs)

218

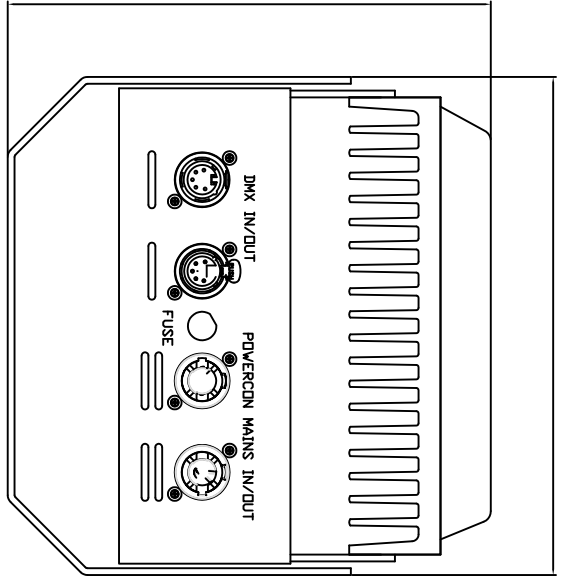

i-PIX "SATELLITE"

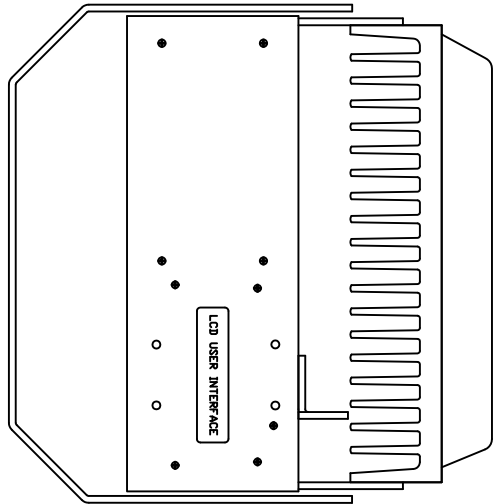

100

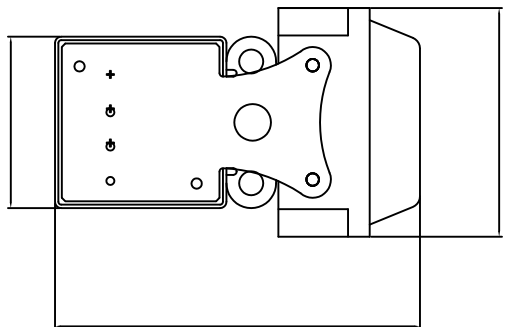

UNDERNEATH VIEW

TOP VIEW

END VIEW WITHOUT YOKE

206

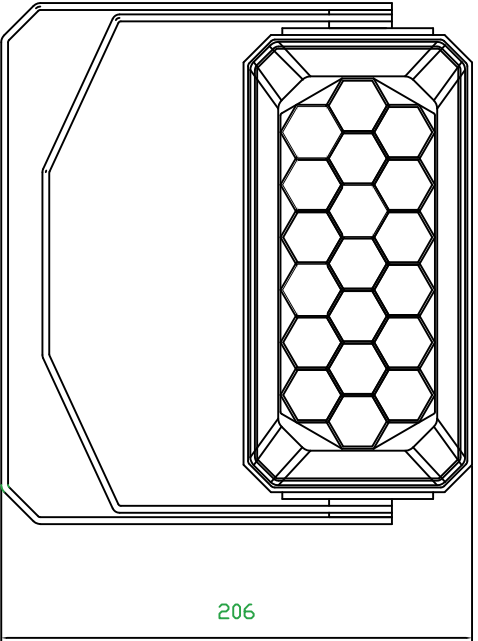

FRONT VIEW WITH OUTER YOKE

END VIEW WITH OUTER YOKE

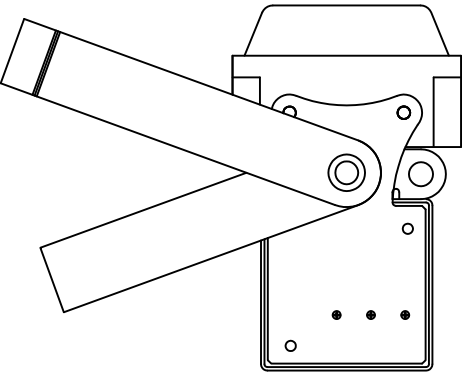

TROUBLE SHOOTING

DISCLAIMER: Please note that the information contained in this trouble-shooting guide is generalized in nature & cannot account for all possibilities. Any proposed remedies for specific situations should not be considered as absolute or all encompassing. Please seek professional assistance if there is any doubt as to the efficacy of a remedy or of the exact nature of any encountered problem. I-pix provides the information contained herein only as a guide.

No response from the light

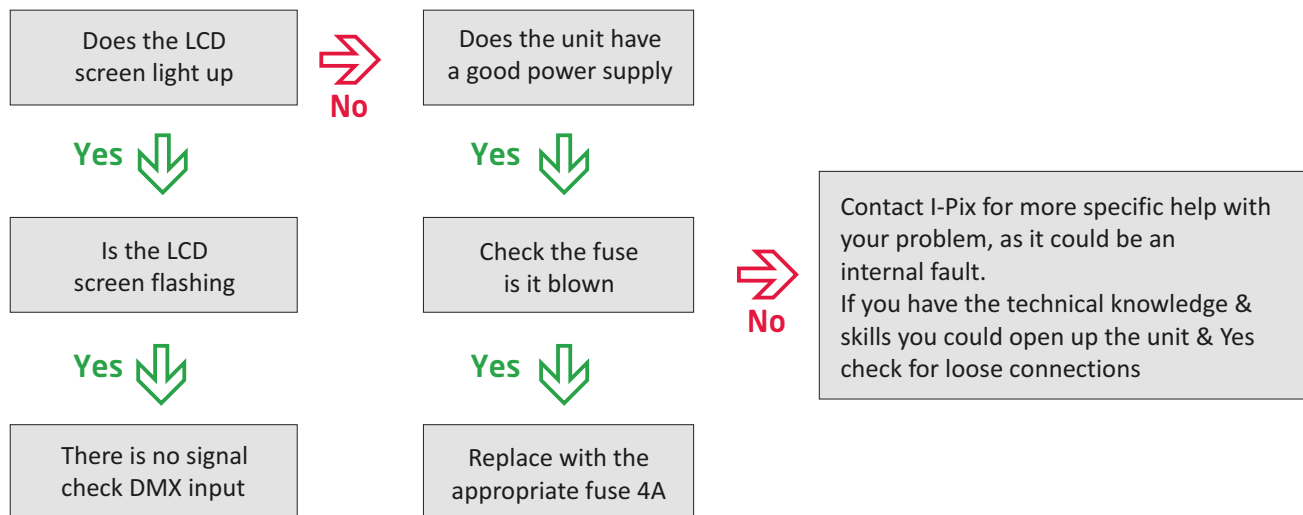

Mains supply keeps tripping out blowing fuses:

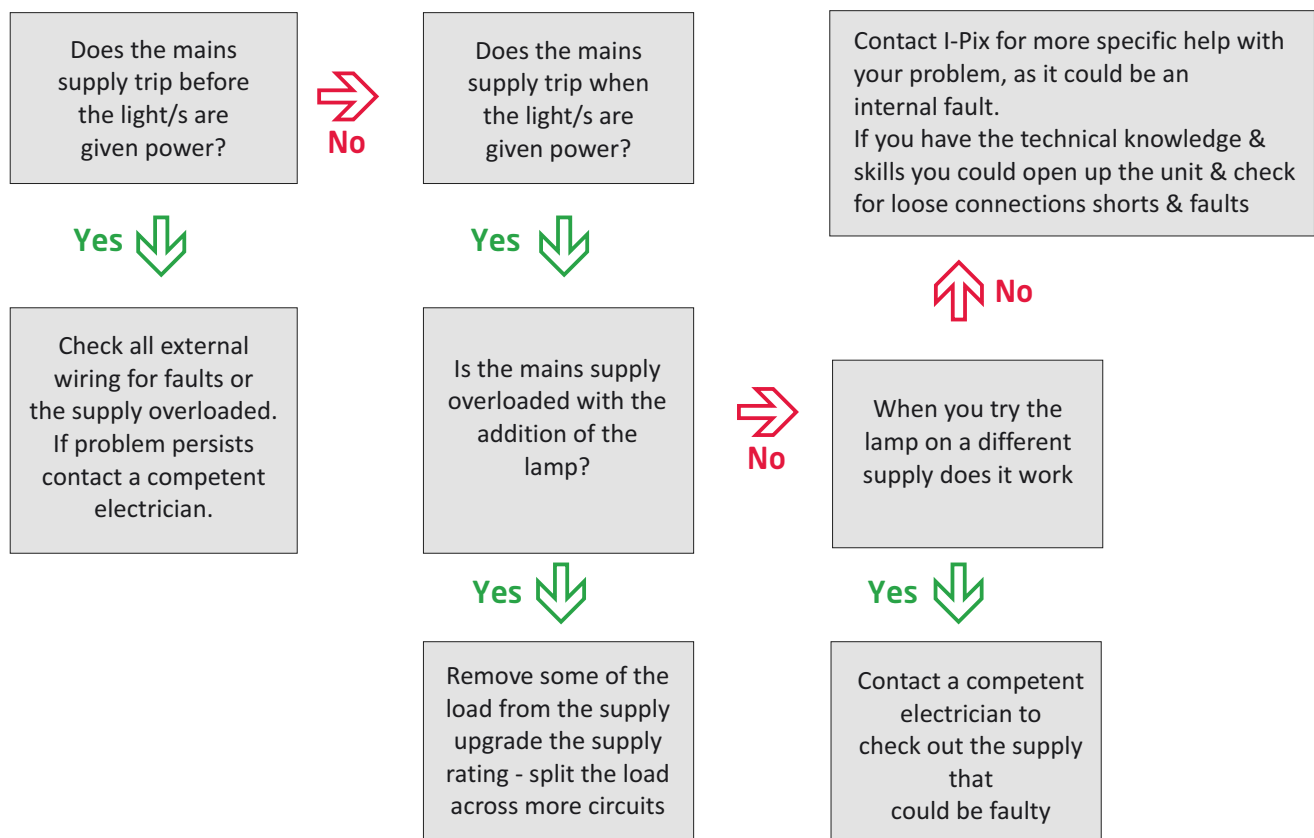

TROUBLE SHOOTING

The fuse on a unit repeatedly blows

- Are you fitting right rating/type of fuse into unit?
- Contact I-pix for more specific help with your problem, there may be an internal fault in the unit.
- If you have the technical knowledge/skills you could look inside the unit and check the internal wiring for a loose connections/shorts and also the power supply is working with a 24v output when there is no load connected to it.

Dmx trouble shooting

The obvious

- It is good practice to connect data line and terminate before switching on device.
- Is the dmx line fitted to a buffer and data is being received.
- Is the dmx data line fitted with a line termination?
- Does the unit's dmx mode set-up match the personality/ profile for the console provided?
- Note: the LCD screen flashes intermittently when no data is present.

RoHS AND WARRANTIES

I-PIX SATELLITEs COMPLY WITH RoHS RESTRICTIONS

I-PIX SATELLITEs are compliant with all of the criteria proposed by the European RoHS directive 2002/95/EC for hazardous material content in electronic and electrical equipment as listed in Annex 1A and 1B of the WEEE Directive.

In addition to containing no mercury, the LED light engines have the following environmental advantages over traditional light sources:

- High energy efficiency
- Long lifetime
- Fully dim-able
- Very low IR and UV radiation

For attachment of electrical connections I-Pix use lead free solder.

WARRANTY STATEMENT

I-Pix (seller) extends warranty on all the electronics in the SATELLITE produced by the Seller for two (2) years from original date of shipment, that the goods sold hereunder are new and free from substantive defects in workmanship and materials. This warranty extends only to the Buyer and not to indirect purchasers or users . Sellers liability under the foregoing warranty is limited to replacement of goods or repair of defects or refund of the purchase price at the Sellers sole option. The above warranty does not apply to defects resulting from the improper or inadequate maintenance, unauthorized modification, improper use or operation outside of Sellers specifications for the product, abuse, neglect, or accident. THE ABOVE WARRANTY IS EXCLUSIVE AND NO OTHER WARRANTY, WHETHER WRITTEN OR ORAL, IS EXPRESSED OR IMPLIED. I-PIX SPECIFICALLY DISCLAIMS THE IMPLIED WARRANTIES OF MERCHANTABILITY AND FITNESS FOR A PARTICULAR PURPOSE - I-PIX Jan 01, 2009

WARRANTY STATEMENT

I-Pix (seller) extends warranty on all the L.E.D.s in the SATELLITE produced by the Seller for one (1) year from original date of shipment, that the goods sold hereunder are new and free from substantive defects in workmanship and materials. This warranty extends only to the Buyer and not to indirect purchasers or users. Sellers liability under the foregoing warranty is limited to replacement of goods or repair of defects or refund of the purchase price at the Sellers sole option. The above warranty does not apply to defects resulting from the improper or inadequate maintenance, unauthorized modification, or improper use or operation outside of Sellers specifications for the product, abuse, neglect or accident. THE ABOVE WARRANTY IS EXCLUSIVE AND NO OTHER WARRANTY, WHETHER WRITTEN OR ORAL, IS EXPRESSED OR IMPLIED. I-PIX SPECIFICALLY DISCLAIMS THE IMPLIED WARRANTIES OF MERCHANTABILITY AND FITNESS FOR A PARTICULAR PURPOSE - I-PIX Jan 01, 2009



i-PIX



SERVICE CONTACT DETAILS

Broadstone Mill
Broadstone Road
Houldsworth Village
Cheshire
SK5 7DL
[Located 4 miles from Manchester airport and the city centre]

Tel: 44 (0)161 443 4140
E-mail: service@i-pix.com

www.i-pix.com